



4年生の計算プリント

■面積の計算 (1)

下記の絵の面積を教えてください。

名前 _____

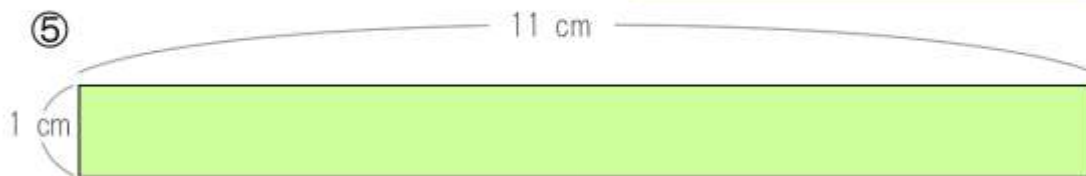
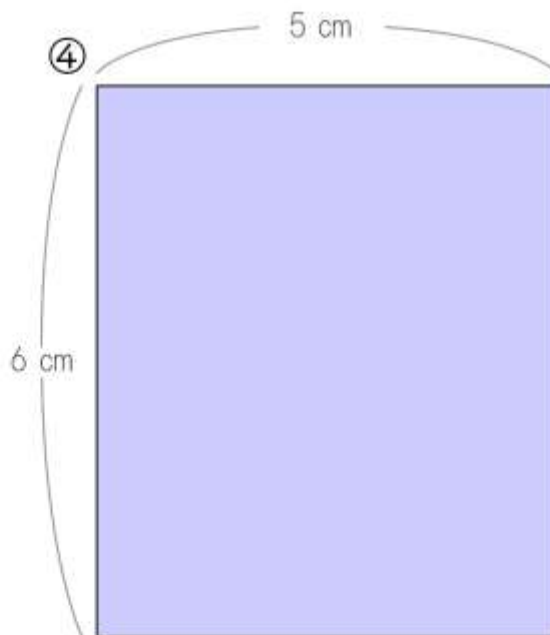
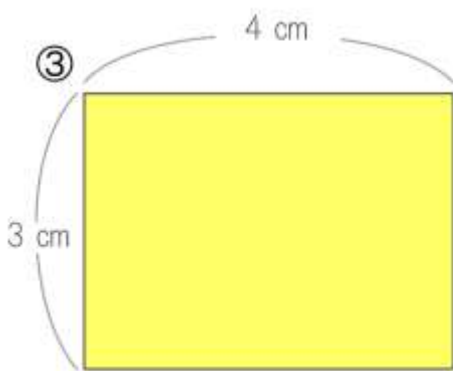
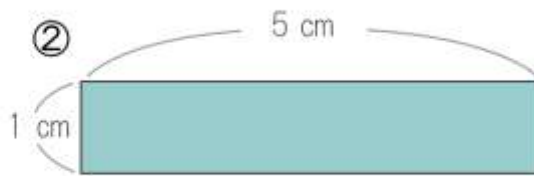
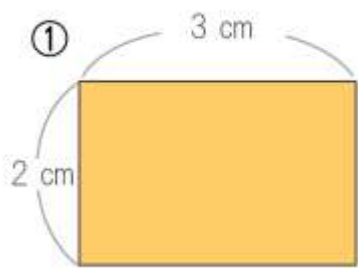

①

②

③

④

⑤



4年生の計算プリント

■面積の計算 (1)

下記の絵の面積を教えてください。

名前 _____

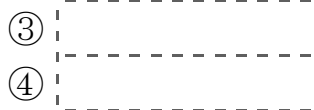
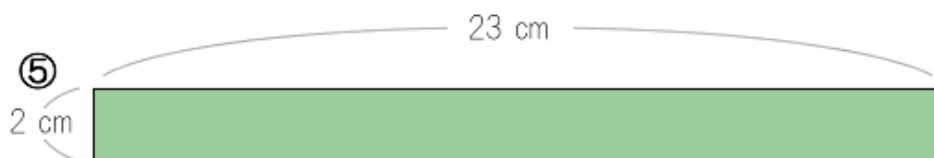
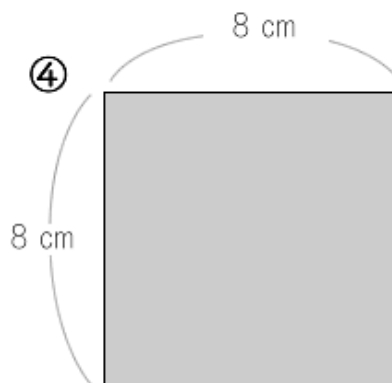
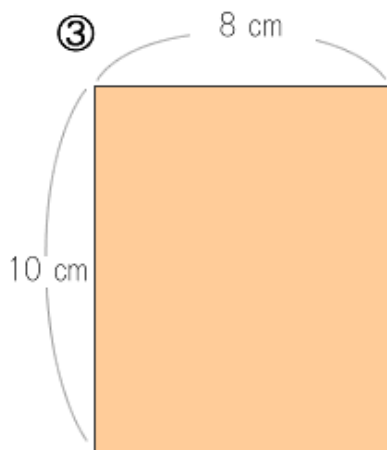
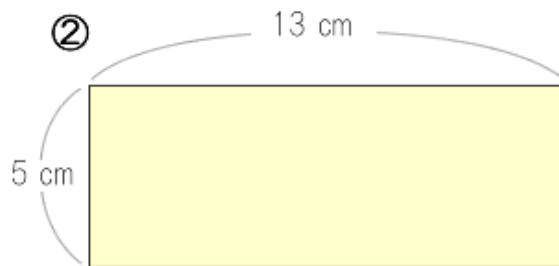
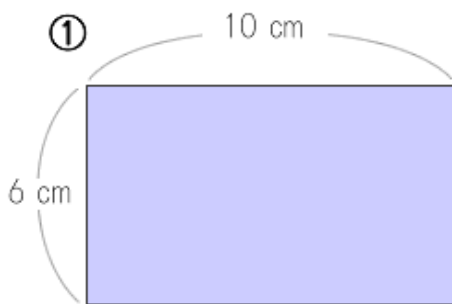



4年生の計算プリント

■面積の計算 (1)

下記の絵の面積を教えてください。

名前 _____

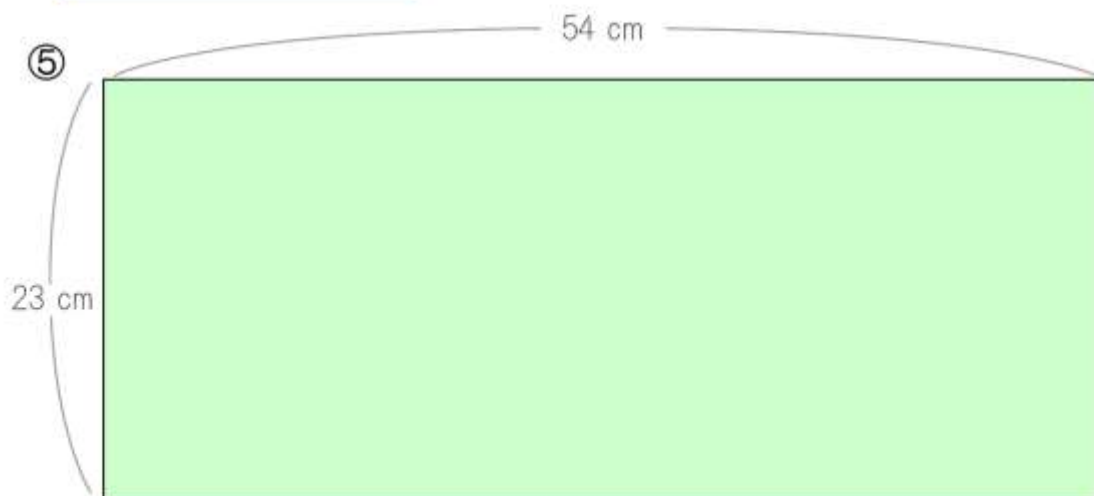
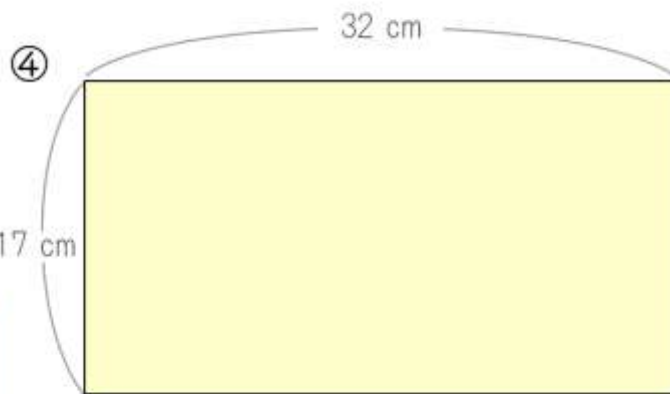
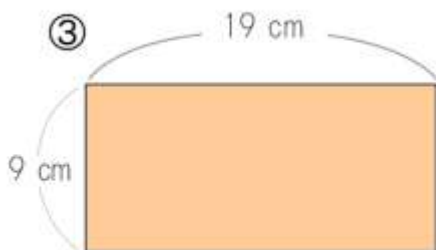
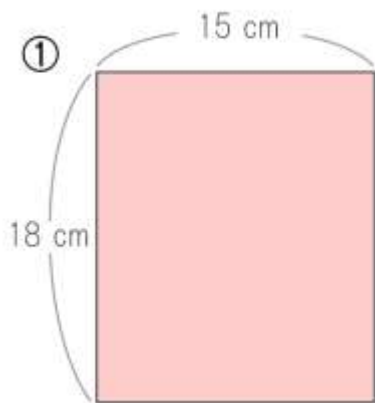

①

②

③

④

⑤



答え ■面積の計算 (1)

page 1 ① 6 cm^2

page 2 ① 60 cm^2

page 3 ① 270 cm^2

② 5 cm^2

② 65 cm^2

② 156 cm^2

③ 12 cm^2

③ 80 cm^2

③ 171 cm^2

④ 30 cm^2

④ 64 cm^2

④ 544 cm^2

⑤ 11 cm^2

⑤ 46 cm^2

⑤ 1242 cm^2